







# More Precision

**eddyNCDT** // Inductive sensors based on eddy currents





-  **Miniature sensor design**
-  **M12 controller - Integration into spindle or flange mounting**
-  **Sensors for ferromagnetic and non-ferromagnetic targets**
-  **Temperature measurement integrated**

### Measuring the thermal extension of spindles

The SGS4701 displacement measuring system (Spindle Growth System) is developed specifically for high speed milling machine applications. Due to high machining speeds and the heat generated, the linear thermal expansion of the spindle in precision machine tools needs to be compensated for in order to keep the tool in a defined position at all times. The SGS sensor measures the thermal and centrifugal force expansion of the spindle. These measurement values are fed into the CNC machine tool as correctional values, compensating for any positioning errors.

The SGS4701 operates on the eddy current measuring principle. This non-contact measurement method is wear-free. Furthermore, the measurement procedure is resistant to disturbances such as heat, dust and oil.

### System design

The SGS 4701 consists of a sensor, a sensor cable and a controller, factory calibrated for ferromagnetic and non-ferromagnetic targets. Two miniature sensors enable it to be installed directly in the spindle, where the measurements take place, typically on the labyrinth-ring of the spindle. As well as measuring linear thermal expansion, the temperature of the sensor is also detected and output. The compact controller can be installed on the spindle housing via a flange or directly in the spindle.

The sensor cable must not be shortened as functionality loss may arise. Removing the connector is only permitted behind the plug-sided crimp when using the solder connections.

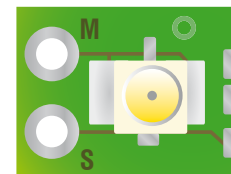

**S** = signal = inner conductor  
**M** = ground = shield = outer conductor

### Customer-specific adjustment

For individual installation situations and measurement objects, sensor and controller can be adjusted in the factory. This enables to achieve the best possible measurement accuracy.

### Pin assignment for power supply and signal

Pin	Assignment	Color (cable: PC4701-x)
1	GND	White
2	Supply 12 ... 32 VDC	Brown
3	Displacement signal	Green
4	Temperature signal	Yellow
5	n.c.	Gray
6	internal	Pink
7	internal	Blue
8	n.c.	Red



5-pin housing connector M12x1  
View on pin side

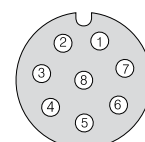

Model	SGS4701	
Measuring range	500 $\mu\text{m}$ (optional 250 $\mu\text{m}$ <sup>1)</sup> )	
Start of measuring range	100 $\mu\text{m}$ (optional 50 $\mu\text{m}$ <sup>1)</sup> )	
Resolution <sup>2)</sup>	0.5 $\mu\text{m}$	
Frequency response (-3dB)	2000 Hz	
Linearity	< $\pm 2 \mu\text{m}$	
Temperature stability	Sensor	< 300 ppm FSO / K
	Controller	< 1000 ppm FSO / K
Temperature compensation	Sensor	+10 ... +80 °C
	Controller	+10 ... +70 °C
Min. target size (flat)	8 mm	
Target material <sup>3)</sup>	Steel, aluminum	
Supply voltage	12...32 VDC	
Analog output	Displacement	0.5 ... 9.5 V (100 ... 600 $\mu\text{m}$ , optional 50 ... 300 $\mu\text{m}$ )
	Temperature	0.5 ... 9.5 V (0 ... +90 °C)
Connection	Sensor: integrated cable <sup>4)</sup> , standard length 1 m (0.4 ... 1.5 m on request), min. bending radius 12 mm Supply/signal: 8-pole M12 connector (cable see accessories)	
Temperature range	Sensor	0 ... +90 °C
	Controller	+10 ... +70 °C
Shock (DIN EN 60068-2-27)	50 g / 6 ms in each direction, 1000 shocks each	
Vibration (DIN EN 60068-2-6)	20 g / 10 ... 3000 Hz	
Protection class (DIN EN 60529)	IP67 (plugged)	
Weight <sup>5)</sup>	approx. 85 g	

FSO = Full Scale Output

<sup>1)</sup> For OEM modifications: sensor with a measuring range of 250  $\mu\text{m}$  and an offset of 50  $\mu\text{m}$  are possible

<sup>2)</sup> Static, relates to mid of measuring range

<sup>3)</sup> Steel: St37 steel DIN1.0037 / aluminum: AlCuMgPb3.1645 / AlMg3

<sup>4)</sup> Detailed cable specifications can be found in the operating instructions

<sup>5)</sup> Total weight for controller, cable and sensor

EMU04(121)

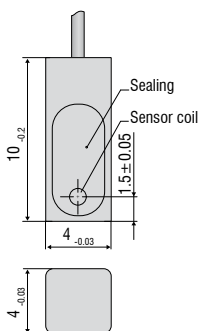

EMU04(102)

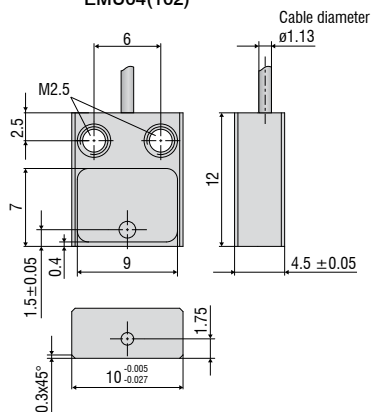

Controller

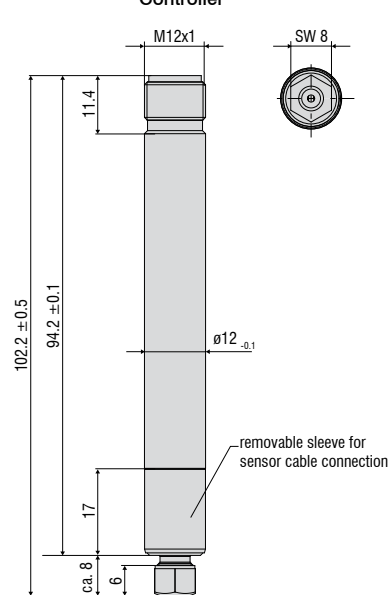

Clamping flange (optional)

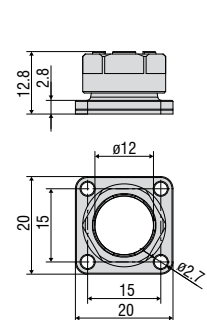

Connector (max. 20 mating cycles possible)

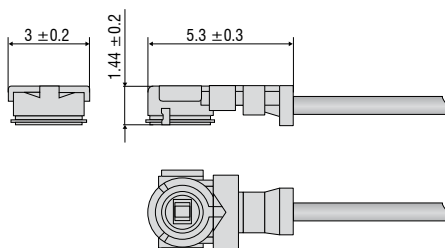

Dimensions in mm, not to scale.

Article	Description	DT3001	DT3005	DT3060	DT3070	DT3300	DZ140	SGS
PCx/8-M12	<b>Supply and signal cable</b> 8-pole with M12 connector Standard length: 3 m Optionally available: 5 m / 10 m / 15 m / 10 m as drag-chain suitable variant			X	X			
PCx/5-M12	<b>Supply and signal cable</b> 5-pole with M12 connector Standard length: 5 m Optionally available: 20 m	X	X					
PC4701-x	<b>Supply and signal cable</b> 8-pole with M12 connector Standard length: 10 m Optionally available: 15 m / 10 m as drag-chain suitable variant							X
SCD2/4/RJ45	<b>Ethernet cable</b> 4-pole with M12 connector on RJ45 connector Standard length: 2 m			X	X			
SCAx/5	<b>Signal cable, analog</b> 5-pole with M16x0.75 connector Standard length: 3 m Optionally available: 6 m / 9 m					X		
SCDx/8	<b>Signal cable for switching inputs and outputs:</b> 8-pole with M16x0.75 connector Standard length: 0.3 m Optionally available: 1 m					X		
PSCx	<b>Supply and synchronization cable</b> 5-pole with M9 connector Standard length: 0.3 m Optionally available: 1 m					X		
ESCx	<b>Synchronization cable</b> 5-pole with M9 connector Standard length: 0.3 m Optionally available: 1 m					X		
PC140-x	<b>Supply and signal cable</b> 8-pole connector Standard length: 3 m Optionally available: 6 m						X	
PS2020	<b>Power supply unit</b> Input 100-240 VAC output 24 VDC / 2.5 A; mounting onto symmetrical standard rail 35 mm x 7.5 mm, DIN 50022	X	X	X	X	X	X	X

## Sensors and Systems from Micro-Epsilon



Sensors and systems for displacement, distance and position



Sensors and measurement devices for non-contact temperature measurement



Measuring and inspection systems for metal strips, plastics and rubber



Optical micrometers and fiber optics, measuring and test amplifiers



Color recognition sensors, LED analyzers and inline color spectrometers



3D measurement technology for dimensional testing and surface inspection